

2020

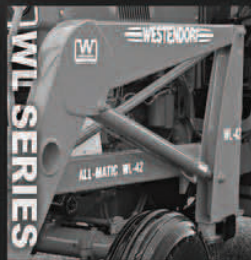

WESTENDORF

SALES MANUAL AND PRICE GUIDE



WAGONS & GEARS



Prices Effective as of 1-21

WESTENDORF WAGONS & GEARS

WESTENDORF HEAVY-DUTY WAGON GEARS

are designed to give you top performance for many years of rugged use. Wagon gears have an extra short turning radius, superior trailing, different tire options, anti-wear bushings, easy coupler tongue, special reach clamp, and the larger models include tongue with spring lift.

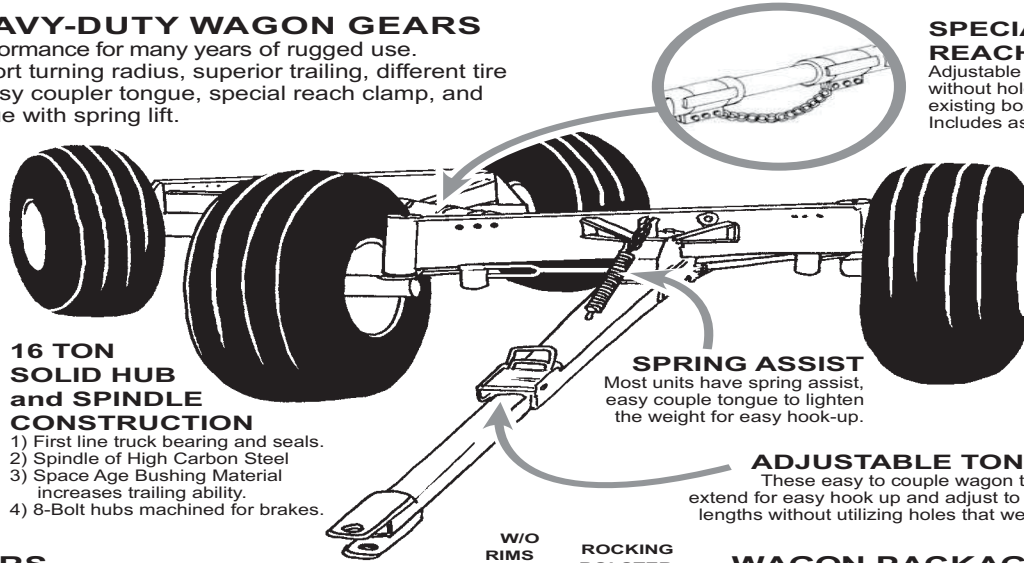

SPECIAL REACH CLAMP
Adjustable to various lengths without holes. Adjust it to fit an existing box, hay rack or flatbed. Includes assurance chain.

16 TON SOLID HUB and SPINDLE CONSTRUCTION
1) First line truck bearing and seals.
2) Spindle of High Carbon Steel
3) Space Age Bushing Material increases trailing ability.
4) 8-Bolt hubs machined for brakes.

SPRING ASSIST
Most units have spring assist, easy couple tongue to lighten the weight for easy hook-up.

ADJUSTABLE TONGUE
These easy to couple wagon tongues extend for easy hook up and adjust to various lengths without utilizing holes that weaken it. *includes box*

WAGON GEARS

Wagon Gear	P/N	Spindle	Tread	Price	Price
10 Ton*	WW-1610	1-15/16"	73"	2,070	273
12 Ton*	WW-2012	2-1/4"	75"	2,794	497
14 Ton	WW-2214	2-1/2"	88"	2,971	N/A
14 Ton Tandem	TW-2014	2-1/4"		5,099	497
16 Ton*	WW-2416	3"	79"	3,519	497

*Please specify stake kit or stake/hinge kit when ordering

WAGON PACKAGES

Bushels	P/N	Gear	Price
300	WW-325	10 Ton	5,960
350	WW-H375	12 Ton	7,316
400	WW-H425	12 Ton	7,611
350	WW-L375	14 Ton	7,504
400	WW-L425	14 Ton	7,805
400	WW-T425	16 Ton	8,365

OPTIONS & UPGRADES

Description

Hydraulic Surge Brakes - factory installed

For models: WW-2012, WW-2214, WW-2416, WW-L425 & WW-H425

This special order item requires extra lead time and is non-cancelable / non-returnable.

P/N	Price
HB-100 (Net Price)	2,172

Lift Kit for WW-L425 is required w/super single tires

P/N	Price
WAC-221	407

Tandem Axle Kit for 8-bolt Hub

converts a single axle gear to a tandem gear

Package includes a set of two tandem axle kits



P/N	Price
TWC-8	1,545

ADD TIRES

Description	Part Num	Tire Size	Ply	Tire Rating	et Price Ea.
New Flotation Tires	T161165	16.5 x 16.1	10	5,500#	619
Regrooved Truck Tires	T110225	11.00 x 22.5	8	6,600#	160
Super Singles*	T150225	15.00 x 22.5	11	8,000#	302

*When using used super single tires, you must have a rim from 1-13/16" to 1-15/16" negative offset

NOTE: Mounting charges are applicable to install tires on rims and rims on gears.

REMEMBER: The wagon capacity can be limited by the accumulative capacity of the rims and tires.

ADD RIMS

P/N	6-Bolt	Price Ea.
1566	15.0 x 6	94
1586	15.0 x 8	119
P/N	8-Bolt	Price Ea.
15108	15.0 x 10	212
16118	16.1 x 11	188
2088	20.0 x 8	188
16148	16.1 x 14	246
2288	22.5 x 8.25	246
22138X	22.5 x 13.5 - 1-13/16	567
	2012, 2214, H375, H425 & L425	
22138	22.5 x 13.5	567
	for WW-2416 & WW-T425	

CAUTION!

Do Not Trail Empty Wagon(s) Over 40 MPH, Especially in Pairs.

Because: (1) Empty wagons bounce. (2) There is no drag on the second unit. (3) Tires and rims in combination aren't balanced. (4) Whip and stopping problems are compounded with speed. SERIOUS DAMAGE MAY RESULT TO YOUR EQUIPMENT THAT COULD ESCALATE INTO MORE SERIOUS PROBLEMS IN TRAFFIC.

The Tire and Rim Companies Further Limit Speed to 20 MPH.



WAGONS & GEARS



Prices Effective as of 1-21

WESTENDORF WAGON PACKAGES & PART IDENTIFICATION

WESTENDORF WAGON PACKAGES

This specially designed box holds up to 400 bushels and features a flow box that empties in about 40 seconds. It has a low profile of 9'1", an easy access ladder with room between the box, and a smooth steel wrap-around-corner for added strength.

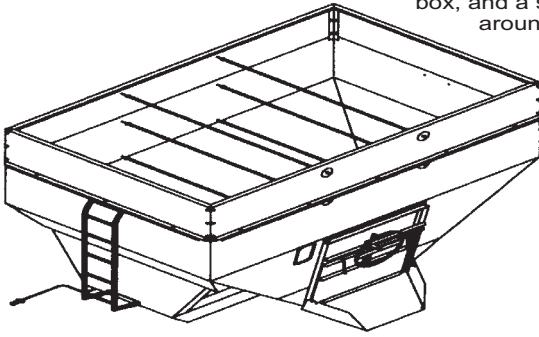

Convenient windows allow you to see how your work is progressing. Brake and directional lights are included for your protection.

- Built-in rocking bolsters
- Computer designed for even load distribution
- Closed formed box resists twisting
- Extra sharp turning radius for flexibility in the field
- Attractive decal package
- Standard with red paint, available with optional tractor matching color

ANHYDROUS WAGON



OURS



THEIRS

Get the 5th Wheel Trailing Advantage!
Reduces the tip-over problem of other anhydrous wagons!

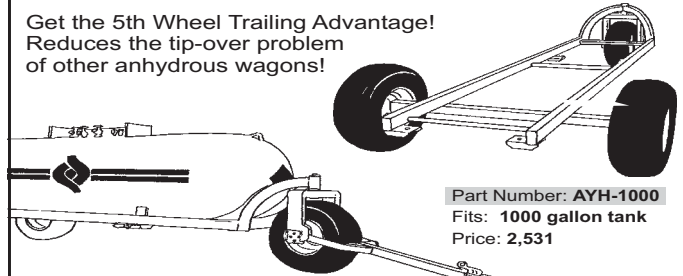

Part Number: **AYH-1000**
Fits: **1000 gallon tank**
Price: **2,531**

- 1) NO Hassle Trailing!
- 2) Low-Profile design adds stability with 3 points of ground contact.
- 3) NO Climbing! This Westendorf anhydrous wagon positions the tank so low, you can access the hook-ups from the ground.

WAGON REPLACEMENT PARTS

WAGONS	Part Number	SPINDLES & HUBS				TIE RODS				TONGUE			Foot Notes
		Front Right Spindle	Front Left Spindle	Rear Spindle	Hub*	Tie Rod Complete	Tie Rod	Rod End	Rod Nut	Tongue Pkg.	Tongue Rear	Tongue Front	
8 TON - 6 bolt hub	WW-16	HW-25AAS-R	HW-25AAS-L	HW-52	WW-16	HW-34COM(73")	HW-34 (73")	HW-37	HFN1414	ECT-16	ET-9AS	ET-1AS	1
10 TON - 6 bolt hub	WW-1610	HW-25AAS-R	HW-25AAS-L	HW-52	WW-16	HW-34COM(73")	HW-34 (73")	HW-37	HFN1414	ECT-16	ET-9AS	ET-1AS	1
12 TON - 8 bolt hub	WW-2012	PW-25EAS-R	PW-25EAS-L	PW-52AS	WW-20	PW-42COM	PW-42	AW-38A	HFN1614	ECT-20	ET-117AS	ET-105AS	2
14 TON - 8 bolt hub	WW-2214	LW-25AAS-R	LW-25AAS-L	LW-52ASUB	WW-20	LW-41COM	LW-41AS	AW-38A	HFN1614	ECT-22	LW-68AAS	LW-66AS	
14 TON TANDEM - 8 bolt	TW-2014	PW-25EAS-R	PW-25EAS-L	PW-52AS	WW-20	PW-42COM	PW-42CAS	AW-38A	HFN1614	ECT-20	ET-117AS	ET-105AS	
16 TON - 8 bolt	WW-2416	AW-328BAS-R	AW-328BAS-R	AW-47ASUB	WW-251	AW-42COM	AW-42	AW-38A	HFN1614	ECT-24	ET-217AS	ET-105AS	3

* To ensure you order the correct replacement hub, check the hub casting for the WW part number.

1: Components also offered in 67" width. Identify 73" or 67" when ordering. Tie Rod: HW-35 Rear Spindle: HW-53

2: Two styles of spindles were offered. See Illustrations Front: PW-25AS (L&R) and PW-25EAS (L&R). Get a diagonal dimension before ordering.



PW-25

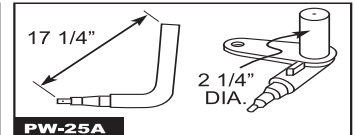

PW-25A

3: Several spindles were offered. Front: AW-128AS (L&R) AW-228AS (L&R) AW-328BAS (L&R) Rear: AW-47SUB and AW-47ASUB

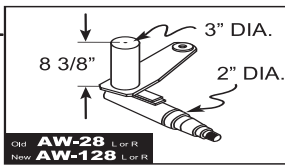

Old AW-28 L or R New AW-128 L or R

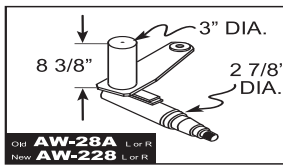

Old AW-28A L or R New AW-228 L or R

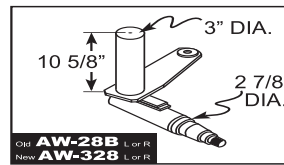

Old AW-28B L or R New AW-328 L or R

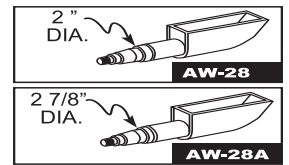

AW-28 AW-28A

HUBS: Illustrations of the most popular hubs are listed to the right.

Be sure and check measurements on older gear models.

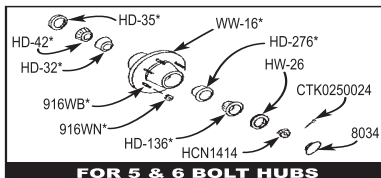

FOR 5 & 6 BOLT HUBS

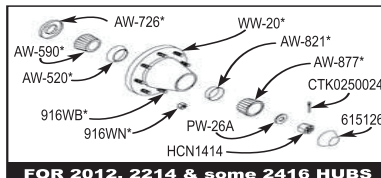

FOR 2012, 2214 & some 2416 HUBS

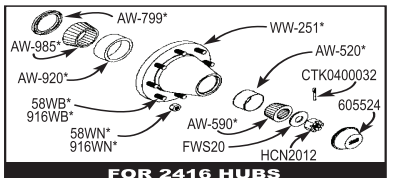

FOR 2416 HUBS

* IMPORTANT: Check measurements and numbers on these items for possible differences in your wagon and this years model.



WAGONS & GEARS



COMPLETE REPLACEMENT CYLINDERS AND PARTS REFERENCE

100 SERIES LOADERS								BUCKET CYLINDER REFERENCE								LIFT CYLINDER REFERENCE								PINS		DECALS	
Cylinder	Seal Kit	Ram	Barrel	Piston	Gland	Footnote		Cylinder	Seal Kit	Ram	Barrel	Piston	Gland	Footnote		Cylinder	Seal Kit	Ram	Barrel	Piston	Gland	Footnote	Pin Kit	Decal Kit			
TA-52 / 54 / 55	B-25	#26CK	L-2510	B-2501	P-F	G-N		L-25	#25CK	L-2510	L-2501	P-G	G-N		L-25	#25CK	L-2510	L-2501	P-G	G-N		PK-1	DEC-55				
TA-111	B-15	#8CK	B-1510	B-1501	P-J	G-I	C	L-15	#7CK	L-1510	B-1501	P-C	G-H		L-15	#7CK	L-1510	B-1501	P-C	G-H		PK-2	DEC-111				
TA-140	B-15	#8CK	L-1510	B-1501	P-C	G-I	C	L-15	#7CK	L-1510	B-1501	P-C	G-H		L-15	#7CK	L-1510	B-1501	P-C	G-H		PK-3	DEC-140				
TA-160	B-9	#7CK	B-910	B-901	P-C	G-H		B-9	#7CK	B-910	B-901	P-C	G-H		B-9	#7CK	B-910	B-901	P-C	G-H		PK-4	DEC-160				
TA-170	B-41	#7CK	B-4110	B-4101	P-C	G-H		L-40	#7CK	L-4010	L-4101	P-C	G-H		L-40	#7CK	L-4010	L-4101	P-C	G-H		PK-5	DEC-170				
TA-175	B-41	#7CK	B-4110	B-4101	P-C	G-H		L-51	#1CK	L-4109	L-5102	P-A	G-A		L-51	#1CK	L-4109	L-5102	P-A	G-A		PK-6	DEC-175				
TA-180	B-39	#1CK	B-3910	B-3901	P-A	G-A		L-38	#1CK	L-3810	L-3801	P-A	G-A		L-38	#1CK	L-3810	L-3801	P-A	G-A		PK-7	DEC-180				
TA-185	B-48	#39CK	B-3910	B-4801	P-A	G-X		L-52	#39CK	L-3810	L-5201	P-A	G-X		L-52	#39CK	L-3810	L-5201	P-A	G-X		PK-8	DEC-185				
WL LOADERS								BUCKET CYLINDER REFERENCE								LIFT CYLINDER REFERENCE								PINS		DECALS	
Cylinder	Seal Kit	Ram	Barrel	Piston	Gland	Footnote		Cylinder	Seal Kit	Ram	Barrel	Piston	Gland	Footnote		Cylinder	Seal Kit	Ram	Barrel	Piston	Gland	Footnote	Pin Kit	Decal Kit			
WL-20	B-1	#1CK	B-110	B-101	P-A	G-A	A	L-8	#1CK	L-810	L-801	P-A	G-A	A, F	L-8	#1CK	L-810	L-801	P-A	G-A	A, F	PK-38					
WL-21	B-1	#1CK	B-110	B-101	P-A	G-A	A	L-9	#5CK	L-910	L-901	P-A	G-B	A, F	L-9	#5CK	L-910	L-901	P-A	G-B	A, F	PK-19	DEC-21				
WL-22	B-1	#1CK	B-110	B-101	P-A	G-A	A	L-8	#1CK	L-810	L-801	P-A	G-A	A, F	L-8	#1CK	L-810	L-801	P-A	G-A	A, F	PK-37					
WL-23	B-6	#1CK	B-110	B-710	P-A	G-A	A	L-8	#1CK	L-810	L-801	P-A	G-A	A, F	L-8	#1CK	L-810	L-801	P-A	G-A	A, F	PK-36					
WL-24	B-7	#1CK	B-710	B-701	P-A	G-A	A, D	L-20	#4CK	L-2010	B-1001	P-B	G-B	A	L-20	#4CK	L-2010	B-1001	P-B	G-B	A	PK-20					
WL-27	B-1	#1CK	B-110	B-101	P-A	G-A		L-35	#5CK	L-3510	B-3501	P-A	G-B		L-35	#5CK	L-3510	B-3501	P-A	G-B		PK-29	DEC-27				
WL-30	B-1	#1CK	B-110	B-101	P-A	G-A	A, B	L-10U	#4CK	L-1010	L-1001	P-B	G-B	A, E	L-10U	#4CK	L-1010	L-1001	P-B	G-B	A, E	PK-33	DEC-30				
WL-40	B-1	#1CK	B-110	B-101	P-A	G-A	A, B	L-10U	#4CK	L-1010	L-1001	P-B	G-B	A, E	L-10U	#4CK	L-1010	L-1001	P-B	G-B	A, E	PK-33	DEC-40				
WL-42	B-1	#1CK	B-110	B-101	P-A	G-A	A, B	L-10E	#4CK	L-1010	L-1001	P-B	G-B	A	L-10E	#4CK	L-1010	L-1001	P-B	G-B	A	PK-21	DEC-42				
WL-42B	B-5	#4CK	B-310	B-501	P-B	G-E	A, D	L-19	#4CK	L-1910	L-1001	P-B	G-B	A	L-19	#4CK	L-1910	L-1001	P-B	G-B	A	PK-31	DEC-42				
WL-44	B-5	#4CK	B-310	B-501	P-B	G-E	A, D	L-20	#4CK	L-2010	L-1001	P-B	G-B	A	L-20	#4CK	L-2010	L-1001	P-B	G-B	A	PK-31	DEC-44				
WL-50	B-1	#1CK	B-110	B-101	P-A	G-A	A	L-6	#4CK	L-610	L-601	P-B	G-B	A, G	L-6	#4CK	L-610	L-601	P-B	G-B	A, G	PK-34	DEC-50				
WL-60	B-1	#1CK	B-110	B-101	P-A	G-A	A, B	L-10	#4CK	L-1010	L-1001	P-B	G-B	A	L-10	#4CK	L-1010	L-1001	P-B	G-B	A	PK-33	DEC-60				
WL-61	B-4	#4CK	B-410	B-401	P-B	G-E	A	L-10	#4CK	L-1010	L-1001	P-B	G-B	A	L-10	#4CK	L-1010	L-1001	P-B	G-B	A	PK-30	DEC-61				
WL-64	B-3	#4CK	B-310	B-301	P-B	G-E	A	L-12	#6CK	B-1210	B-1201	P-B	G-D	A	L-12	#6CK	B-1210	B-1201	P-B	G-D	A	PK-22	DEC-64				
WL-110	B-15	#8CK	B-1510	B-1501	P-C	G-I	C	L-15	#7CK	L-1510	B-1501	P-B	G-B		L-15	#7CK	L-1510	B-1501	P-B	G-B							
WL-357	B-16	#4CK	B-1610	B-1601	P-B	G-E	A	L-17	#16CK	L-1710	L-1701	P-E	G-J	A	L-17	#16CK	L-1710	L-1701	P-E	G-J	A						
WL-421	B-4	#4CK	B-410	B-401	P-B	G-B	A, H	L-20	#4CK	L-2010	L-1001	P-B	G-B	A, H	L-20	#4CK	L-2010	L-1001	P-B	G-B	A, H						
WL-457	B-16	#4CK	B-1610	B-1601	P-B	G-K	A	L-16	#16CK	L-1610	L-1601	P-E	G-J	A	L-16	#16CK	L-1610	L-1601	P-E	G-J	A						
WL-467	B-16	#4CK	B-1610	B-1601	P-B	G-K	A	L-16	#16CK	L-1610	L-1601	P-E	G-J	A	L-16	#16CK	L-1610	L-1601	P-E	G-J	A						
WL-576	B-1	#1CK	B-110	B-101	P-A	G-A	A, B	L-20	#4CK	L-2010	L-1001	P-B	G-B	A	L-20	#4CK	L-2010	L-1001	P-B	G-B	A	PK-32	DEC-576				
TA LOADERS								BUCKET CYLINDER REFERENCE								LIFT CYLINDER REFERENCE								PINS		DECALS	
Cylinder	Seal Kit	Ram	Barrel	Piston	Gland	Footnote		Cylinder	Seal Kit	Ram	Barrel	Piston	Gland	Footnote		Cylinder	Seal Kit	Ram	Barrel	Piston	Gland	Footnote	Pin Kit	Decal Kit			
TA-25	B-9	#7CK	B-910	B-901	P-C	G-H		L-23	#1CK	B-910	L-2301	P-A	G-A		L-23	#1CK	B-910	L-2301	P-A	G-A		PK-9	DEC-25				
TA-26	B-10	#1CK	B-1010	B-1001	P-A	G-A		L-18	#4CK	L-1810	L-1801	P-B	G-L		L-18	#4CK	L-1810	L-1801	P-B	G-L		PK-10	DEC-26				
TA-26PLUS	B-10	#1CK	B-1010	B-1001	P-A	G-A		L-45	#4CK	L-4510	L-4501	P-B	G-L		L-45	#4CK	L-4510	L-4501	P-B	G-L		PK-11	DEC-26PLUS				
TA-2612	B-10	#1CK	B-1010	B-1001	P-A	G-A		L-28	#4CK	L-2810	L-2801	P-B	G-L		L-28	#4CK	L-2810	L-2801	P-B	G-L		PK-12	DEC-2612				
TA-28	B-1	#1CK	B-110	B-101	P-A	G-A	B	L-41	#4CK	L-4110	L-4101	P-B	G-L		L-41	#4CK	L-4110	L-4101	P-B	G-L		PK-13	DEC-28				
TA-28PLUS	B-24	#4CK	B-2410	B-2401	P-B	G-L		L-34	#4CK	L-3410	L-3401	P-B	G-L		L-34	#4CK	L-3410	L-3401	P-B	G-L		PK-14	DEC-28PLUS				
TA-29	B-36	#4CK	B-3610	B-3601	P-B	G-L		L-41	#4CK	L-4110	L-4101	P-B	G-L		L-41	#4CK	L-4110	L-4101	P-B	G-L		PK-15	DEC-29				
TA-229	B-24	#4CK	B-2410	B-2401	P-B	G-L		L-28	#4CK	L-2810	L-2801	P-B	G-L		L-28	#4CK	L-2810	L-2801	P-B	G-L		PK-16	DEC-45				
TA-45	B-24	#4CK	B-2410	B-2401	P-B	G-L		L-24	#4CK	L-2410	L-2401	P-B	G-L	L	L-24	#4CK	L-2410	L-2401	P-B	G-L	L	PK-17	DEC-46				
TA-46	B-24	#4CK	B-2410	B-2401	P-B	G-L		L-24	#4CK	L-2410	L-2401	P-B	G-L		L-24	#4CK	L-2410	L-2401	P-B	G-L		PK-18	DEC-48				
TA-48	B-37	#4CK	B-3710	B-3701	P-B	G-L		L-12	#6CK	L-1210	L-1201	P-B	G-D	J	L-12	#6CK	L-1210	L-1201	P-B	G-D	J	PK-17	DEC-76				
TA-76	B-26	#4CK	B-2410	B-2601	P-B	G-L		L-29	#29CK	L-1210	L-2901	P-I	G-R		L-29	#29CK	L-1210	L-2901	P-I	G-R		PK-17	DEC-77				
TA-77	B-26	#4CK	B-2410	B-2601	P-B	G-L																					
XTA LOADERS								BUCKET CYLINDER REFERENCE								LIFT CYLINDER REFERENCE								PINS		DECALS	
Cylinder	Seal Kit	Ram	Barrel	Piston	Gland	Footnote		Cylinder	Seal Kit	Ram	Barrel	Piston	Gland	Footnote		Cylinder	Seal Kit	Ram	Barrel	Piston	Gland	Footnote	Pin Kit	Decal Kit			
XTA-400	B-34	#4CK	B-2410	B-3401	P-B	G-L		L-33	#4CK	L-3310	L-3301	P-B	G-L	K	L-33	#4CK	L-3310	L-3301	P-B	G-L	K	PK-23	DEC-400				
XTA-400B	B-35	#4CK	B-2410	B-3501	P-B	G-L		L-33	#4CK	L-3310	L-3301	P-B	G-L	K	L-33	#4CK	L-3310	L-3301	P-B	G-L	K	PK-24	DEC-400				
XTA-700	B-24	#4CK	B-2410	B-2401	P-B	G-L		L-64	#53CK	L-6410	L-6401	P-Z	G-U	M,N	L-64	#53CK	L-6410	L-6401	P-Z	G-U	M,N	PK-25	DEC-700				
XTA-700A	B-24	#4CK	B-2410	B-2401	P-B	G-L		L-64	#53CK	L-6410	L-6401	P-Z	G-U	M,N	L-64	#53CK	L-6410	L-6401	P-Z	G-U	M,N	PK-25	DEC-700				
CC LOADERS								BUCKET CYLINDER REFERENCE								LIFT CYLINDER REFERENCE								PINS		DECALS	
Cylinder	Seal Kit	Ram	Barrel	Piston	Gland	Footnote		Cylinder	Seal Kit	Ram	Barrel	Piston	Gland	Footnote		Cylinder	Seal Kit	Ram	Barrel	Piston	Gland	Footnote	Pin Kit	Decal Kit			
CC-330	B-59	#46CK	B-5910	B-5901	P-U	G-W	M,P	L-46A	#1CK	L-4610A	L-4601	P-B	G-L		L-46A	#1CK	L-4610A	L-4601	P-B	G-L		PK-26	DEC-330				
CC-340	B-59	#46CK	B-5910	B-5901	P-U	G-W	M,P	L-44	#41CK	L-4210	L-4401	P-B	G-L		L-44	#41CK	L-4210	L-4401	P-B	G-L		PK-27	DEC-340				
CC-360	B-60	#52CK	B-6010	B-6001	P-R	G-U	M,Q	L-43	#31CK	L-4310	L-4301	P-B	G-L-5		L-43	#31CK	L-4310	L-4301	P-B	G-L-5		PK-28	DEC-360				
CC-370	B-53	#35CK	B-5310	B-5301	P-B	G-W		L-64	#53CK	L-6410	L-6401	P-Z	G-U	M,N	L-64	#53CK	L-6410	L-6401	P-Z	G-U	M,N	PK-29	DEC-370				
FM LOADERS								BUCKET CYLINDER REFERENCE								LIFT CYLINDER REFERENCE								PINS		DECALS	
Cylinder	Seal Kit	Ram	Barrel	Piston	Gland	Footnote		Cylinder	Seal Kit	Ram	Barrel	Piston	Gland	Footnote		Cylinder	Seal Kit	Ram	Barrel	Piston	Gland	Footnote	Pin Kit	Decal Kit			
FM-540	B-71	#54CK	B-7110																								

WAGONS & GEARS

Prices Effective as of 1-21



CYLINDER PARTS (CONT.)

ATTACHMENT & ACCESSORY CYLINDERS		CYLINDER REFERENCE						
PRODUCT	Part No.	Cylinder	Seal Kit	Ram	Barrel	Piston	Gland	Opt.
Jiffy Monster Grab Fork	GF-20	B-1	#1CK	B-110	B-101	P-A	G-A	
Monster Grab Fork	GF-28	B-1	#1CK	B-110	B-101	P-A	G-A	
Sabretooth	GF-32	M-3	#1CK	B-310	B-301	P-A	G-A	
Monster Grab Fork	GF-51	B-1	#1CK	B-110	B-101	P-A	G-A	
Monster Grab Fork	GF-52	B-1	#1CK	B-110	B-101	P-A	G-A	
Quick Mount Claw Grab	GF-64	M-8	#1CK	M-810	M-801	P-A	G-A	
Triple Action Cat Claw	GF-84 GF-96	M-10	#7CK	M-1010	M-1001	P-C	G-H	
Triple Action Cat Claw	GF-184 GF-196	M-10	#7CK	M-1010	M-1001	P-C	G-H	
Brush Crusher	BC-6000 BC-7000 BC-8000	M-15	#34CK	M-1510	M-1501	P-J	G-V	
Landscraper	WL-8	L-2 (LIFT)	#4CK	L-210	L-201	P-B	G-B	
	WL-10	M-3 (TILT)	#1CK	B-310	B-301	P-A	G-A	OPT.
	WL-12		#1CK	B-310	B-301	P-A	G-A	
Bale Handler	BH-15	M-3	#1CK	B-310	B-301	P-A	G-A	
High Lifter	HL-30	M-2	#4CK	M-210	M-201	P-B	G-L	
High Lifter	HL-20	M-3	#1CK	M-310	M-301	P-A	G-A	
3 Point	3P-H	M-5	#20CK	M-510	M-501	P-F	G-N	
Auto Dump	WR-40	M-2	#4CK	M-210	M-201	P-B	G-L	
Feeder Bucket	Z-47	M-2	#4CK	M-210	M-201	P-B	G-L	
Squeezer	SQ-80	D-1	#10CK	D-110	D-101	P-B	G-B	
Thrifty Lift™	HFC	M-6 (LIFT)	#17CK	M-1110	M-1101	M-1154	G-L	
		M-7* (TILT)	#4CK	M-1210	M-1201	P-B	G-L	OPT.
		M-9* (TILT)	#4CK	M-1310	M-1201	P-B	G-L	OPT.
Bale Grab	BG-34	M-3	#1CK	M-310	M-301	P-A	G-A	

*Measure Ram to Identify which tilt option was selected. M-7 has a 21" ram and M-9 has a 18" ram.

HITCH-N-GO™

Part Number: HNG

Easily attach wagons, hay racks, trailers and more to the tractor quickly and easily from your seat.

- Strong hydraulic cylinder pushes drawbar pin in and out with ease.
- Patented spring mechanism allows trailing over rough terrain without bending hitch pin or cylinder.
- Less Stress - pulls directly from drawbar for greater strength & safety

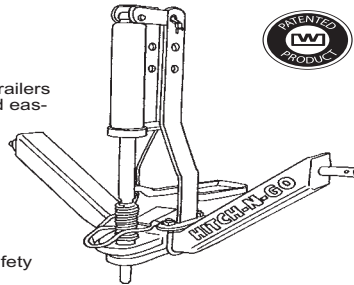

HITCH-N-GO

P/N	Description	Price
HNG	Hitch-N-Go with 1" or 7/8" pin	750
HNG-PTO	PTO Unit for use with Hitch-N-Go	225
HNG-DBE	Hitch-N-Go Drawbar Extension	100
HNG-QHA	Quick Hitch Adapter for Hitch-N-Go	30

LOW BOY TRAILER

Part Number: LBT-20

Price: 9,275



The easiest trailer to load! This trailer lies flat on the ground; just drive right over it to load/unload.

- 1) Accessible from three sides for easy loading and unloading
- 2) Adjust wheel position while driving to balance the load.
- 3) Minimum space required to operate! Great for unloading in barns or tight spaces; the wheels move, not the trailer.

