

Worksaver



Striking the right balance; tough, reliable, rugged.



Split-Top Grapple Rake

The attachment that started it all, the Split-Top grapple rake is designed for use on tractor front loaders as well as skid steers. Available in two widths, 62" and 77", these units feature two upper grapples working independent of each other, allowing the unit to retain uneven loads. The lower tines with their replaceable wear points allows the grapple to pick up brush, logs, orchard pruning, brush piles and other debris while leaving the dirt behind – letting the operator get more work done.

- Unique tine design with weld-on tine points.
- Tine design allows operator to go under logs/brush for easy clean pick up.
- Interfacing quick-attach brackets available for most tractor loader models including John Deere, AGCO, CNH, Bush Hog and others.
- Greaseable pivot points on upper clamps for long service life.
- Shield plate in upper clamps provides protection to hydraulic cylinders.



Compact Grapple Rake

Designed for compact tractors up to 40 horsepower that are equipped with a front loader. This 60-inch wide grapple allows the acreage owner unsurpassed versatility in clearing brush, piling limbs or orchard maintenance. Ideal for loading limbs, orchard prunings, piling brush and other hard to handle materials.

- Unique upper grapple design provides clamping force to hold material securely.
- Design allows brush and other materials to be picked up while leaving the dirt.
- Size compatible with the lift capacity of most small loader tractors.
- Good forward visibility for easy control in close quarters for increased productivity.
- Simple efficient design with few moving parts for long life.
- Pivot points have lubrication capabilities.
- Tractor front loader model allow use of standard pin-on bracket or select interfacing quick attach brackets for John Deere, AGCO, CNH, Kubota and other brands.



Split-Top Grapple Rake Specifications

	FLGR-262 / SSGR-262 / FLGR-262-G	FLGR-277 / SSGR-277 / FLGR-277-G
Overall Width (in/mm)	62 / 1575	77 / 1956
Overall Depth (in/mm)	25 / 635	25 / 635
Overall Height Closed (in/mm)	54 / 1372	54 / 1372
Grapple Opening (in/mm)	50 / 1270	50 / 1270
Upper Grapple Widths (in/mm)	19.25 / 489	19.25 / 489
Tine Spacing (in/mm)	15 / 381	15 / 381
Number of Tines/Grapples (lower/upper)	5 / 4	6 / 4
Reinforcing Tubes Between Lower Tines	Yes	Yes
Number of Hydraulic Cylinders	2	2
Cylinder Bore (in/mm)	2 / 50.8	2 / 50.8
Cylinder Stroke (in/mm)	10 / 254	10 / 254
Cylinder Rod Diameter (in/mm)	1.125 / 28.57	1.125 / 28.57
Cylinder Pressure Rating (psi/bar)	3000 / 206.9	3000 / 206.9
Mounting for Tractor Loader (FLGR)	Mgt. Brt. Available*	Mgt. Brt. Available*
Weight FLGR Model (lbs/kg)	811 / 368	958 / 435
Mounting for Skid Steer (SSGR)	"Universal" Skid Steer	"Universal" Skid Steer
Weight SSGR Model (lbs/kg)	820 / 372	965 / 438
Mounting for FLGR-G Models	Euro / Global	Euro / Global
Weight FLGR-G Models (lbs/kg)	827 / 375	970 / 440
Horsepower Rating (maximum)	95 PTO HP	150 PTO HP
Product No. FLGR Models (loader)	811380	811400
Product No. SSGR Models (skid steer)	811435	811440
Product No. FLGR-G Models (Euro/Global)	811495	811490

*Optional interfacing quick attach brackets available for most popular loaders. (Skid Steer/Global models have mounting brackets incorporated into their design).



WARNING: Read and understand the operator's manual before operation. Be sure tractor/skid steer is properly counterbalanced. Damage to equipment or personal injury could occur.

Compact Grapple Rake Specifications – Designed for tractors up 40 HP only

	FLGR-4062	FLGR-4062S
Overall Width (in/mm)	60 / 1524	60 / 1524
Overall Depth (in/mm)	23 / 584.2	23 / 584.2
Overall Height Closed (in/mm)	38.77 / 984.75	38.77 / 984.75
Grapple Opening (in/mm)	27 / 685.8	27 / 685.8
Upper Grapple Widths (in/mm)	34 / 836.6	34 / 836.6
Tine Spacing (in/mm)	15 / 381	15 / 381
Number of Lower Tines	5	5
Reinforcing Tubes Between Lower Tines	Yes	Yes
Number of Hydraulic Cylinders	1	1
Cylinder Bore (in/mm)	2 / 50.8	2 / 50.8
Cylinder Stroke (in/mm)	8 / 203.2	8 / 203.2
Cylinder Rod Diameter (in/mm)	1.125 / 28.57	1.125 / 28.57
Cylinder Pressure Rating (psi/bar)	3000 / 207	3000 / 207
Mounting for Tractor Loader (FLGR)	Mgt. Brt. Available *	"Universal" Skid Steer
Weight FLGR Model (lbs/kg)	359 / 180.98	364 / 180.98
Product No. FLGR Models (loader)	811460	811480

*Optional interfacing quick attach brackets available for most popular loaders.



WARNING: Read and understand the operator's manual before operation. Be sure tractor/skid steer is properly counterbalanced. Damage to equipment or personal injury could occur.

Mini Skid Steer/Compact Tool Carrier Grapple



This tool consistently delivers high performance while offering the owner a great return on investment. Model MGU-48 is designed to fit any unit with the "Universal Mini Mount" (Toro-Dingo, Boxer, Ditch Witch, Ramrod, etc.). Model MGB/G-48 is designed to fit the Bobcat MT-series as well as the Gehl 1640E. Overall unit width is 48". Offers great versatility in clearing brush, piling limbs, orchard prunings or other hard to handle materials.

- Single upper grapple provides clamping force to hold material securely.
- Mainframe design allows brush and other materials to be picked up while leaving the dirt.
- Good forward visibility for easy control in close quarters for increased productivity.
- Hoses and couplers are standard equipment.

Mini Skid Steer/Compact Tool Carrier Grapple Specifications

	MGU-48	MGB/G-48
Overall Width (in/mm)	48 / 122	48 / 122
Overall Height Closed (in/mm)	32.75 / 832	32.75 / 832
Upper Grapple Width (in/mm)	31 / 787	31 / 787
Tine Spacing (in/mm)	7.5 / 191	7.5 / 191
Reinforcing Tubes Between Lower Tines	Yes	Yes
Number of Hydraulic Cylinders	1	1
Mounting Type	"Universal Mini Skid"	Bobcat MT-Series
Weight (lbs./kg)	290 / 132	310 / 141
Product No.	811730	811740



WARNING: Read and understand the operator's manual before operation. Be sure tractor/skid steer is properly counterbalanced. Damage to equipment or personal injury could occur.

Worksaver



Low Profile Scrap Bucket

Designed for skid steers, the LPSB series scrap bucket provides material handling on the construction site for moving demolition debris, rocks, brush, and dirt. Ideal for storm clean-up, landscaping, or moving hard to handle materials. Features 3,000 psi cylinders with cylinder guards to protect the cylinders and components. Through the tube hose routing provides hose protection. In addition, hose routing down the left-hand back of the bucket results in maximum dump and roll back as optimum hose length is maintained. Hose routing can be reversed to right-hand side for JCB models. Connect under pressure flat-face couplers are standard. The scrap bucket's cutting edge is drilled to accept an optional replaceable and reversible beveled cutting edge which provides increased bucket strength while extending bucket life.



Low Profile Tine Grapple

Designed for skid steers, the LPTG series tine grapple easily moves rocks, brush, wood, metal and other materials while leaving the dirt on the

ground. The grapple is ideal for various applications including construction site demolition and clean-up, storm clean-up, and landscaping. Features include 5-1/2" tine spacing, 3,000 psi cylinders with cylinder guards to protect the cylinders and components. Hoses are routed through the tube to provide hose protection. In addition hose routing down the left hand back of the bucket results in maximum dump and roll back as optimum hose length is maintained. Connect under pressure flat-face couplers are standard.

ETG Series Tine Grapple

Designed for use on skid steers (and tractor front loaders) utilizing the "Universal" skid steer attaching system. Also available to fit John Deere 300/400/500 series loaders. Ideal for raking, piling, and loading brush and other hard to handle materials while leaving dirt behind.

- Unique upper grapple design provides clamping force to hold material securely.
- Greaseable pivot points on upper grapple for long service life.
- Low profile design offers great forward visibility.
- Shield plate on upper grapple provides protection for hydraulic cylinder.
- Hoses with couplers are routed through the tube to provide hose protection.
- ETG-26 features dual upper grapples for additional clamping of uneven loads.

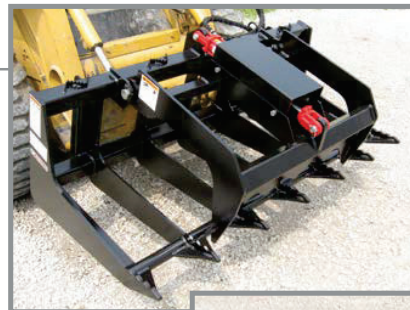

Low Profile Scrap Bucket Specifications

	LPSB-72	LPSB-78	LPBS-84
Overall Width (in/mm)	72 / 1829	78 / 1981	84 / 2134
Bucket Depth (in/mm)	26 / 660	26 / 660	26 / 660
Grapple Opening (in/mm)	36.5 / 930	36.5 / 930	36.5 / 930
Cylinder Pressure Rating (psi/bar)	3000 / 207	3000 / 207	3000 / 207
Couplers	1/2 / 13 Body – Connect Under Pressure		
Mount Type	"Universal Skid Steer"		
Weight (lbs/kg)	791 / 359	823 / 373	855 / 388
Product No.	811780	811820	811860
Optional Bolt-on Reversible Cutting Edge (in/mm)	3/4 x 8 / 19 x 203 x Bucket Width		
Bolt-on Edge Product No.	811790	811830	811870
Bolt-on Cutting Edge Weight (lbs/kg)	115 / 52	125 / 57	135 / 61

Low Profile Tine Grapple Specifications

	LPTG-72	LPTG-78	LPTG-84
Overall Width (in/mm)	72 / 1829	78 / 1981	84 / 2134
Tine Spacing (in/mm)	5.5 / 140	5.5 / 140	5.5 / 140
Number of Tines	14	15	16
Tine Length (in/mm)	29.5 / 750	29.5 / 750	29.5 / 750
Grapple Opening (in/mm)	36.5 / 927	36.5 / 927	36.5 / 927
Cylinder Pressure Rating (psi/bar)	3000 / 207	3000 / 207	3000 / 207
Couplers	1/2 / 13 Body – Connect Under Pressure		
Mount Type	"Universal Skid Steer"		
Weight (lbs/kg)	820 / 372	864 / 392	896 / 406
Product No.	811750	811800	811840



WARNING: Read and understand the operator's manual before operation. Be sure tractor/skid steer is properly counterbalanced. Damage to equipment or personal injury could occur.

ETG Series Tine Grapple Specifications

	ETG-5	ETG-6	ETG-26	ETG-5JD	ETG-6JD
Overall Width (in/mm)	61.5 / 1562	71.75 / 1822	71.75 / 1822	61.5 / 1562	71.75 / 1822
Overall Depth (in/mm)	35.5 / 901	35.5 / 901	35.5 / 901	35.5 / 901	35.5 / 901
Inside Depth (in/mm)	28.5 / 724	28.5 / 724	28.5 / 724	28.5 / 724	28.5 / 724
Overall Height (in/mm)	25.5 / 648	25.5 / 648	25.5 / 648	25.5 / 648	25.5 / 648
Grapple Opening (in/mm)	34 / 864	34 / 864	34 / 864	34 / 864	34 / 864
Upper Grapple Width (in/mm)	34 / 864	34 / 864	20 / 508	34 / 864	34 / 864
Number of Tines	7	8	8	7	8
Tine Spacing (in/mm)	10 / 254	10 / 254	10 / 254	10 / 254	10 / 254
Cylinder Pressure Rating (psi/bar)	3000 / 207	3000 / 207	3000 / 207	3000 / 207	3000 / 207
Couplers	1/2 / 13 Body – Connect Under Pressure			Pioneer Type	
Integral Mounting System	"Universal" Skid Steer			300/400/500 Series JD	
Weight (lbs/kg)	470 / 213	498 / 226	570 / 259	460 / 209	489 / 222
Horsepower Range	30 – 80 HP	30 – 80 HP	30 – 80 HP	30 – 80 HP	30 – 80 HP
Product Item No.	811020	811025	811090	811080	811085

*Optional interfacing quick attach brackets available for most popular loaders.



WARNING: Read and understand the operator's manual before operation. Be sure tractor/skid steer is properly counterbalanced. Damage to equipment or personal injury could occur.

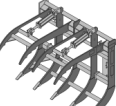
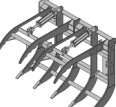
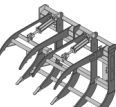

Material Handling Attachments

Designed for Use on Tractor Front Loaders					
Units are priced less any brackets. Pin-on or quick attach brackets ordered separately.					
Product	Model	Item #	Description	Lbs.	List
	FLGR-262	811380	Front Loader Split Top Grapple Rake. 62" wide. Two upper grapples. Two 2" x10" hydraulic cylinders. Optional interfacing brackets available. Less Hose & couplers	811	4,403.00
	FLGR-277	811400	Front Loader Split Top Grapple Rake. 77" wide. Two upper grapples. Two 2" x10" hydraulic cylinders. Optional interfacing brackets available. Less Hose & couplers	884	5,089.00
	Parking Stand Kit	811395	Grapple Parking Stand Kit. Fits all grapples except Mini grapples. Allows upright storage and easy hook up on hard surfaces.	26	259.00
Global / Euro Style Integrated Frame Split Top Grapples					
Features all welded frame that incorporates the Euro-Style implement hook standard integrated into them allowing them to easily hook-up to the Euro / Global-Style quick-attach tool carrier.					
	FLGR-262G	811495	Front Loader Split Top Integrated Grapple Rake 62" wide. Two upper grapples. Two 2" x 10" hydraulic cylinders. Less Hoses & couplers Integrated Euro / Global implement hooks standard	827	4,956.00
	FLGR-277G	811490	Front Loader Split Top Integrated Grapple Rake 77" wide. Two upper grapples.. Two 2" x 10" hydraulic cylinders. Less Hoses & couplers Integrated Euro / Global implement hooks standard	970	5,642.00
Hose Extension Kits – Tractor Loaders					
The Hose Extension Kit enables loader-mounted hydraulic attachments, such as grapples, to be connected and plumbed into the rear remotes of the tractor					
	15-ft Kit	2505856	Two 1/2" hoses, 15-ft long with 1/2" flat face couplers on one end and ISO Couplers (Pioneer Style) on one end to connect to remotes. Bolt-on / Weld-on mounting bracket included	16	380.00
	25-ft Kit	2505857	Two 1/2" hoses, 25-ft long with 1/2" flat face couplers on one end and ISO Couplers (Pioneer Style) on one end to connect to remotes. Bolt-on / Weld-on mounting bracket included	24	465.00

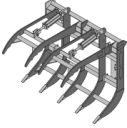
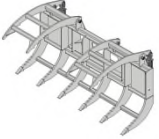

Material Handling Attachments

Skid Steer Mount Grapples					
These products are manufactured to interface with the “Universal “skid steer quick attach mounting.					
	SSGR-262	811435	Skid Steer Split Top Grapple Rake. Unit is 62” wide with two upper grapples, for handling a variety of materials. Unit is equipped with two 2” x10” hyd. cylinders. Hoses less couplers	812	4,893.00
	SSGR-277	811440	Skid Steer Split Top Grapple Rake. Unit is 77” wide with two upper grapples, for handling a variety of materials. Unit is equipped with two 2” x10” hyd. cylinders. Hoses less couplers	943	5,572.00
	SSGR-84	812500	Skid Steer Brush Grapple. Designed for easy access into Skid Steers with a cab door. Two upper grapples, each 19.25” in width to retain debris Hoses less couplers	836	5,719.00
	Parking Stand Kit	811395	Grapple Parking Stand Kit. Fits all grapples except Mini grapples. Allows upright storage and easy hook up on hard surfaces.	26	259.00

Material Handling Attachments

Designed for Use on Skid Steer Loaders					
These products are manufactured to interface with the “Universal “skid steer quick attach mounting. Hoses are routed through the tube for increased protection. Cylinder guards are standard					
Product	Model	Item #	Description	Lbs.	List
Solid Bottom Low Profile Grapple Skid Steer Mount					
	LPSB-72A	812525	Heavy Duty Skid Steer Low Profile Scrap Bucket. 72” overall width. Cutting edge is drilled to accept a replaceable beveled cutting edge. Complete with “connect under pressure” flat-faced couplers	791	4,522.00
	LPSB-78A	812545	Heavy Duty Skid Steer Low Profile Scrap Bucket, 78” width	823	5,187.00
	LPSB-84A	812565	Heavy Duty Skid Steer Low Profile Scrap Bucket, 84” width.	855	5,579.00
End Plate Kit		811795	Bolt-on end plate kit for HD Scrap Buckets. 21” long, 19” high, to enclose ends, bolts and nuts included		147.00
Optional Bolt-on Cutting Edge (3/4” x 8”)		811790	Bolt-on beveled cutting edge for LPSB-72A. Pre-drilled w/ hardware	115	581.00
Optional Bolt-on Cutting Edge (3/4” x 8”)		811830	Bolt-on beveled cutting edge for LPSB-78A. Pre-drilled w/ hardware	125	630.00
Optional Bolt-on Cutting Edge (3/4” x 8”)		811870	Bolt-on beveled cutting edge for LPSB-84A. Pre-drilled w/ hardware	135	672.00
Tine Grapple Low Profile Skid Steer Mount					
	LPTG-72A	812535	Heavy Duty Skid Steer Low Profile Tine Grapple. 72” overall width. Tines spaced 5 ½”. Complete with “connect under pressure” flat-faced couplers	820	4,403.00
	LPTG-78A	812555	Heavy Duty Skid Steer Low Profile Tine Grapple, 78” overall width	864	5,110.00
	LPTG-84A	812575	Heavy Duty Skid Steer Low Profile Tine Grapple, 84” overall width.	896	5,285.00
Low Profile Tine Grapple Euro / Global Mount (shipped w/ hoses, less couplers)					
	LPTG-72G	812640	72” Low Profile tine grapple with Euro / Global mount. Shipped w/ hoses less couplers		4,403.00
	LPTG-78G	812645	78” Low Profile tine grapple with Euro / Global mount. Shipped w/ hoses less couplers		5,110.00
	LPTG-84G	812650	78” Low Profile tine grapple with Euro / Global mount. Shipped w/ hoses less couplers		5,285.00

Material Handling Attachments

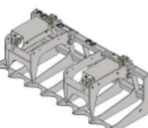
ETG – Economy Tine Grapple for Skid Steer & Tractor Front Loaders Models feature “universal” skid steer mounting interface. For Power Units from 30-55 hp.					
	ETG-5	811020	Low-Profile Tine Grapple for 30-55 hp. skid steer & tractors loaders w/ “Universal” skid steer attaching system. 61” wide w/ single upper grapple 7-tines spaced 10”. Includes hoses, “connect under pressure” flat-face couplers	415	2,716.00
	ETG-6	811025	Low-Profile Tine Grapple 72” width for 30-55 hp. skid steers & tractor front loaders with “universal” skid steer attaching system. 8 lower tine spaced 10” single upper grapple. Includes hose w/ “connect under pressure” flat-face couplers	445	2,863.00
	ETG-26	811090	Low-Profile Tine Grapple with Dual Upper Grapples for 30-55 hp. skid steers & tractor front loaders with “universal” skid steer attaching system. 72” wide with 8-lower tines spaced 10”. Includes hoses & flat-face couplers	525	2,933.00
ETG- Economy Series Designed to fit John Deers Series Loaders w/Quick- Change Carrier All welded construction that incorporates the JD hook& pin quick attach mount. For Power units 30-55 hp					
Product	Model	Item #	Description	Lbs.	List
	ETG-5-JD	811080	Low-Profile Tine Grapple with single upper grapple. For JD quick-change attachment carrier. Unit is 61” wide Includes hoses (less couplers)	420	2,688.00
	ETG-6-JD	811085	Low-Profile Tine Grapple with single upper grapple. For JD quick-change attachment carrier Unit is 72” wide Includes hoses (less couplers)	450	2,835.00
	ETG-26-JD	811075	Low-Profile Grapple with Dual Upper Grapples 72” wide. For JD quick-change attachment carrier. Includes hoses (less couplers)	530	2,905.00

Material Handling Attachments

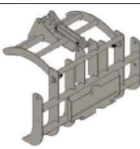
Compact Tine Grapple for Tractors up to 35 Engine HP Designed for Compact Tractors equipped with a loader. "Universal" skid steer mount or JD quick-change attachment carrier, hook & pin (300 /400 Series)					
	CTMG-48S	811850	48" wide Grapple for Compact tractors with loaders that utilize the "universal" skid steer quick attach mounting. Single 31" wide grapple provides clamping force. Shipped Less Hoses & Fittings	320	2,135.00
	CTMG-48JD	811855	Mini Grapple for John Deere Compacts equipped with loaders that use the JD 200/300/400/D120/H120/H130/H160 bucket quick- attach (JD hook & pin). Over width 48", upper grapple 31" Shipped Less Hoses and Fittings	310	2,170.00
Mini Tine Grapple for Sub-Compact Tractors up to 30 Engine HP Designed for Sub-Compact tractors equipped with a loader. Either "Universal skid steer mount or JD quick-change attachment carrier (200X, 200CX, D120, H120, H130, 220R, D160)					
	SCG-48S	811690	48" Grapple for Sub-Compact Tractors with loaders that utilize "universal" skid steer mount. Shipped less hoses / Fittings	205	1,855.00
	SCG-48JD	811670	48" Grapple for JD Sub-Compact Tractors with loader that use JD hook & pin Shipped less hoses & Fittings	200	1,869.00
Mini Skid Steer Grapples For use on Mini Skid Steers / Compact Tool Carriers Overall unit width 48-inches					
	MGU-48	811730	Grapple Designed for Mini Skid Steers / Compact Tool Carriers w/ universal mini mount. Single upper grapple 31" wide, Includes hoses & couplers	290	2,198.00
	MGB/G-48	811740	Grapple Designed for Bobcat MT – series (MT-50, MT-52, MT-55) & S-70 and Gehl 1640E Single upper grapple 31" wide, Includes hoses & couplers	310	2,261.00
Mini SARG Grapple for Mini Skid Steer					
	SARG-42	812230	Sweep Action Rock Grapple designed for Mini Skid Steers / Compact Tool Carriers. Unit is 42" wide with 1" round tines spaced 2.5" apart. Upper Sweep Action Grapple puts rocks/debris in the bucket, with "connect under pressure" flat face couplers	445	3,080.00
	Optional Bolt-in Bottom	812265	Optional Bolt-in 10-gauge bottom for SARG-42 provides bucket bottom to retain very small material	33	119.00



Material Handling Attachments

Electric Mini Tine Grapple for Sub-Compact Tractors up to 32 Engine HP Designed for Sub-Compact tractors equipped with a loader. Upper grapple is controlled by a linear actuator, direct wired to tractors' battery to provide the power. Mounts to either "Universal skid steer mount or JD quick-change attachment carrier (200X, 200CX, D120, H120, H130, 220R, D160)				
ESCG-48S	811880	48" Electric grapple for Sub-compact tractors w/loaders with "universal" skid steer mount. Includes wiring harness & rocker switch to allow installation with connection to tractors battery	247	2,849.00
ESCG-48JD	811885	48" Electric grapple for Sub-compact tractors w/loaders with JD hook & pin quick attach (200X, 200CX, D120, H120, H130, D160, 220R). Includes wiring harness & rocker switch to allow installation with connection to tractors battery	240	2,877.00

Material Handling Attachments

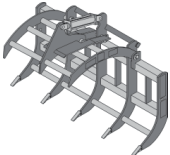
Grapple Rakes for Compact Tractors up to 50 Engine HP Model FLGR-4062 is priced less brackets. Brackets must be ordered separately (below). Model FLGR-4062S design incorporates “universal” quick attach system.					
Product	Model	Item #	Description	Lbs.	List
	FLGR-4062	811460	Designed for Compact Tractor Front Loaders. Grapple Rake is 60-inch wide for picking up hard to handle materials. Single cylinder controls upper grapple. Optional interfacing brackets for most compact loaders available. Shipped less hoses	364	2,639.00
	FLGR-4062S	811480	For Compact Tractor Front Loaders w/ “universal” quick attach system. 60-inch wide for picking up hard to handle materials. Single cylinder controls upper grapple. Not for skid steers (ETG Series Grapples page 14) Shipped less hoses	355	2,877.00
Parking Stand Kit		811395	Parking stand kit to allow upright storage	26	259.00
Interfacing Brackets for FLGR-4062 Grapple Rake and 5-ft, / 6-ft SBFL Snow Blades.					
Model	Item #	Description		Lbs.	List
	811235	Designed for pin on Loaders with 1” Pins (pair)		58	308.00
	811220	Designed for pin-on loaders with ¾” pins (pair)		58	315.00
	811240	Designed for pin-on loaders with 1-1/8” pins (pair)		59	322.00
	811245	Designed for pin-on loaders with 1-3/16” pins (pair)		59	322.00
	811250	Designed for pin-on loaders with 1-1/4” pins (pair)		60	322.00
Branson	811295	Branson Interfacing Brackets for Models BL10A, BL20A		45	441.00
John Deere	811260	John Deere Interfacing Brackets for models H160, H165, H180, D160, D165, 300, 300CX, 410, 420, 430, 440, 460, 400X when used with FLGR-4062		55	532.00
Kubota	811280	Kubota Interfacing Brackets for Model LA1001 when using FLGR-4062		55	504.00
Kubota	811285	Kubota Interfacing Brackets for Model LA1251 when using FLGR-4062		60	490.00
Kubota	811290	Kubota Interfacing Brackets for Model LA852 when using FLGR-4062		62	490.00
Massey Ferguson	811265	MF Brackets for Models 1462, 1464, 1515, 1520, 1525, for FLGR-4062		58	490.00
MF	811220	MF Brackets for DL-100, 1525 loader			315.00
TYM	811265	TYM Interfacing Brackets for Model TL-300		58	490.00
	811275	Bolt-on “Universal” Skid Steer Style bracket for FLGR-4062		90	476.00

NOTE: These interfacing brackets fit only compact tractor attachments.

Worksaver



Manure Forks

- Designed for picking up manure, matted straw or other loose materials.
- Produces cleaner stalls with less physical effort.
- Excellent for handling silage, upper grapple helps secure load during transport improving productivity.
- All units feature forged cranked tines for extended service life.
- Units with upper grapple and skid steer mount are supplied with hoses and connect under pressure couplers for ease of installation.
- Models with upper grapple have greaseable pivot points for long life.
- Cylinder pivot points utilize replaceable harden bushing to reduce wear.
- Models with upper grapples can be used for picking up tree limbs and brush increasing their versatility.
- Mount types: John Deere, "Universal" Skid Steer, and models to accept bolt-on front loader brackets.

Manure Forks Specifications

Manure / Silage / Debris Forks Designed for use on Skid Steers and Tractor Front Loaders
Models interface with loaders that use the "universal" skid steer mount system

Model	M/S-60S	M/S-66S	M/S-72S	M/SG-60S
Overall Width (in/mm)	59.5 / 1511	66 / 1676	71.5 / 1816	59.5 / 1511
Overall Depth (in/mm)	31 / 787	31 / 787	31 / 787	31 / 787
Overall Height (in/mm)	21.5 / 546	21.5 / 546	21.5 / 546	23.5 / 597
Upper Grapple (in/mm)	No	No	No	Yes
Upper Grapple Width (in/mm)	N/A	N/A	N/A	34 / 864
Useable Tine Length (in/mm)	27 / 686	27 / 686	27 / 686	27 / 686
Number of Tines	8	9	10	8
Forged Tine Type	Cranked	Cranked	Cranked	Cranked
Tine Spacing (in/mm)	7.5 / 190	7.5 / 190	7.5 / 190	7.5 / 190
Mounting Type	Skid Steer	Skid Steer	Skid Steer	Skid Steer
Weight (lbs/kg)	225 / 102	240 / 109	270 / 122	375 / 170
Product No.	812305	812400	812315	812310

Manure / Silage / Debris Forks Designed for use on Tractor Front Loaders
Models interface with John Deere Series Loaders

Model	M/S-50JD	M/S-60JD	M/S-66JD	M/S-72JD	M/SG-60JD
Overall Width (in/mm)	50 / 1270	59.5 / 1511	66 / 1676	71.5 / 1816	59.5 / 1511
Overall Depth (in/mm)	31 / 787	31 / 787	31 / 787	31 / 787	31 / 787
Overall Height (in/mm)	21.5 / 546	21.5 / 546	21.5 / 546	21.5 / 546	23.5 / 597
Upper Grapple (in/mm)	No	No	No	No	Yes
Upper Grapple Width (in/mm)	N/A	N/A	N/A	N/A	34 / 864
Useable Tine Length (in/mm)	27 / 686	27 / 686	27 / 686	27 / 686	27 / 686
Number of Tines	7	8	9	10	8
Forged Tine Type	Cranked	Cranked	Cranked	Cranked	Cranked
Tine Spacing (in/mm)	7.5 / 190	7.5 / 190	7.5 / 190	7.5 / 190	7.5 / 190
Mounting Type	JD 200 / 300	JD 400 / 500	JD 400 / 500	JD 400 / 500	JD 400 / 500
Weight (lbs/kg)	185 / 84	220 / 100	245 / 111	268 / 122	365 / 166
Product No.	812300	812335	812410	812345	812340



WARNING: Read and understand the operator's manual before operation. Be sure tractor/skid steer is properly counterbalanced. Damage to equipment or personal injury could occur.

Choose Worksaver For All Your Material Handling

Material Handling Attachments

Manure / Silage / Debris Forks Designed for Use on Skid Steer Loaders / Tractor Loaders

These products (S-models) are manufactured to interface with the “Universal “skid steer quick attach system.

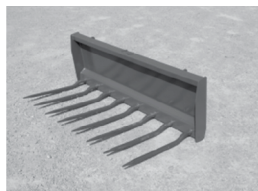
Product	Model	Item #	Description	Lbs.	List
	MF/S-50S	812620	Manure / Silage fork 50-inches in width for Sub-compact tractors with loader. 7 straight tines of 1-1/8 alloy steel. Integrated skid steer style mount	146	938.00
	MF/S-60S	812625	Manure / Silage Fork, 60-inches in width for sub-compact / compact tractors. 8 straight tines of 1-1/8” alloy steel. Integrated skid steer style mount	172	1,176.00
	M/S-66S	812400	Manure / Silage Fork, 66-inches in width. Units features <u>9-forged cranked tines</u> spaced 7-inches apart. Integrated mount to interface with “universal” skid steer mounting system.	240	1,519.00
	M/S-72S	812315	Manure / Silage Fork, 72-inches in width. Units features <u>10-forged cranked tines</u> spaced 7-inches apart. Integrated mount to interface with “universal” skid steer mounting system.	270	1,575.00

Manure / Silage / Debris Forks Designed for Use on Tractor Loaders

Models are offered to interface with John Deere series Loaders, with hook & pin quick attach.

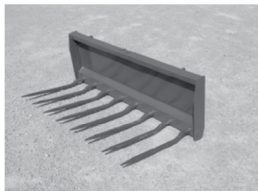
Product	Model	Item #	Description	Lbs.	List
Manure / Silage / Debris for John Deere Loaders that use the JD quick-change attachment carrier					
	MF/S-50JD	812630	Manure / Silage Fork, 50-inches in width. Unit features 7 -straight tines of 1-1/8” alloy steel. Interfaces with JD 200 / 300 / D120 / H120/ H130 loaders (Not compatible with 240, 245,260,265).	141	966.00
	MF/S-60JD	812635	Manure / Silage Fork, 60 inches in width. Unit features 8-straight tine of 1-1/8” alloy steel. Interfaces with JD 400 / D120/ H120 /H130 /220R /D160 loaders.	167	1,204.00
	M/S-66JD	812410	Manure / Silage Forks 66-inches in width. <u>9-forged cranked tine</u> . Interfaces with JD 400 / 500 / D160 / D170 / H160 / H165 / H180 series loaders	245	1,540.00
	M/S-72JD	812345	Manure / Silage Fork, 72 inches in width. Unit features <u>10-forged cranked tine</u> . Interfaces with JD 400 / 500 /D160 / D170 /H160 / H165 / H180 loaders	268	1,603.00

Worksaver



SARG Sweep Action Rock Grapple



Handles Rocks and So Much More – Revolutionizing the way rock grapples work, the SARG (Sweep Action Rock Grapple) from Worksaver makes life easier. With its patent pending design, the SARG allows the operator to own one tool to sort large or small debris, resulting in low cost of ownership. The front grapple operates in a sweeping action to pull rocks or debris into the unit. Grapple design retains the rocks or debris, allowing the operator to rock the attachment to sift dirt out of the material. Rocks, brush, logs, stumps, debris or scrap, the SARG handles them all.

Also available is the SAMB, Sweep Action Material Bucket. The SAMB features a solid bottom designed bucket with sweep action upper grapples to pull debris into the unit. Reversible beveled bolt-on cutting edge is standard equipment, providing increased bucket strength while extending bucket life.



See it in action!



Worksaver is taking a different approach to material handling needs.

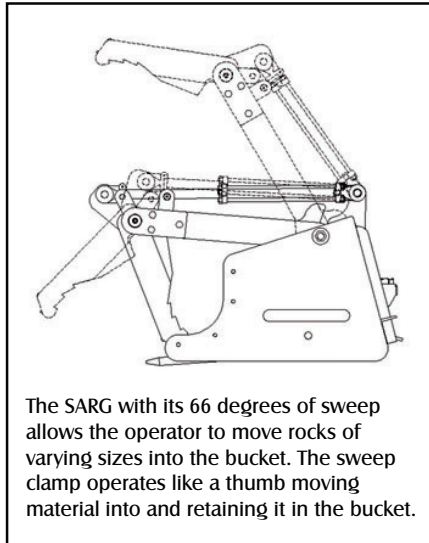

(Right) Bolt-on side plates hold smaller rocks in the bucket. They can be removed from the bucket to allow the SARG to handle logs and stumps.

	SARG-72	SARG-84	SAMB-72	SAMB-84
Overall Width (in/mm)	72 / 1829	84 / 2134	72 / 1829	84 / 2134
Bucket Depth (in/mm)	34 / 864	34 / 864	32 / 813	32 / 183
Upper Grapple Width (in/mm)	34 / 864	40 / 1016	34 / 864	40 / 1016
Length of Sweep Clamp (in/mm)	21 / 533	21 / 533	21 / 533	21 / 533
Degrees of Sweep	66	66	66	66
Grapple Opening (in/mm)	45 / 1143	45 / 1143	45 / 1143	45 / 1143
Cylinder Size (in/mm)	2 x 14 / 51 x 356	2 x 14 / 51 x 356	2 x 14 / 51 x 356	2 x 14 / 51 x 356
Tine Diameter (in/mm)	1.25 / 31.75	1.25 / 31.75	N/A	N/A
Solid Bottom	N/A	N/A	Yes	Yes
Removeable End Plates	Standard	Standard	Standard	Standard
Bolt On Cutting Edge	N/A	N/A	Standard	Standard
Mount Type	"Universal Skid Steer"	"Universal Skid Steer"	"Universal Skid Steer"	"Universal Skid Steer"
Weight (lbs/kg)	1194 / 542	1375 / 610	1075 / 488	1210 / 549
Product No.	812120	812160	812180	812190



WARNING: Read and understand the operator's manual before operation. Be sure tractor/skid steer is properly counterbalanced. Damage to equipment or personal injury could occur.

Sweep Action Tine & Solid Bottom Grapples

SATG & SASB (Sweep Action Grapple) for Use on Skid Steer Loaders and Tractor Front Loaders

The SATG & SASB features upper grapples with 44-degrees of sweep allowing the operator to move debris of varying sizes into the bucket. The sweep clamps operates like fingers moving material into and retaining it in the bucket. Hydraulic hoses are routed through the frame for added protection of components.

Product	Model	Item #	Description	Lbs.	List
Sweep Action Tine Grapple Skid Steer Mount					
	SATG-72	812540	Sweep Action Tine Grapple. 72" width, with 21" wide sweep clamps (Patent Pending) Complete with hoses & flat-faced couplers.	847	5,138.00
	SATG-78	812560	Sweep Action Tine Grapple. 78" width, with 21" wide sweep clamps (Patent Pending) Complete with hoses & flat-faced couplers	893	5,845.00
	SATG-84	812580	Sweep Action Tine Grapple. 84" width, with 21" wide sweep clamps (Patent Pending) Complete with hoses & flat-faced couplers	896	6,020.00
Sweep Action Tine Grapple Euro / Global Mount					
	SATG-72G	812680	72" Sweep Action Tine Grapple with Euro/Global mount, shipped with hoses, less couplers.	840	5,138.00
	SATG-78G	812690	78" Sweep Action Tine Grapple with Euro/Global mount, shipped with hoses, less couplers.	885	5,845.00
	SATG-84G	812700	84" Sweep Action Tine Grapple with Euro/Global mount, shipped with hoses, less couplers.	890	6,020.00

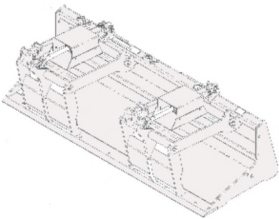
SASB (Sweep Action Grapple) for Use on Skid Steer Loaders And Tractor Front Loaders					
Sweep Action Solid Bottom Grapple Skid Steer Mount					
	SASB-72	812530	HD Solid Bottom scrap bucket 72" width, with 21" wide sweep clamps (Patent Pending) Complete with hose & flat-faced couplers	815	5,257.00
	SASB-78	812550	HD Solid Bottom scrap bucket 78" width, with 21" wide sweep clamps (Patent Pending) Complete with hoses & flat-faced couplers	839	5,922.00
	SASB-84	812570	HD Solid Bottom scrap bucket 84" width, with 21" wide sweep clamps (Patent Pending) Complete with hoses & flat-faced couplers	853	6,314.00
Opt. Bolt-on Edge w/ hardware		811790	Optional bolt-on cutting edge for SASB-72, 3/4" x 8" x 72"	115	581.00
Opt. Bolt-on Edge w/ hardware		811830	Optional bolt-on cutting edge for SASB-78, 3/4" x 8" x 78"	125	630.00
Opt. Bolt-on Edge w/ hardware		811870	Optional bolt-on cutting edge for SASB-84, 3/4" x 8" x 84"	135	672.00

Sweep Action Rock Grapples

SARG (Sweep Action Rock Grapple) for Use on Skid Steer Loaders

The “SARG” features upper grapples with 66-degrees of sweep allowing the operator to move rocks of varying sizes into the tine bucket. The sweep clamp operates like a thumb moving material into and retaining it in the bucket. Hydraulic hoses are routed through the frame for added protection of components. Bolt-on side plates hold smaller rocks in the bucket. Hoses are routed through the tube for increased protection.

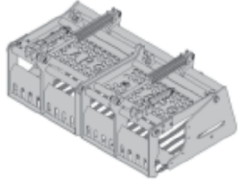
Product	Model	Item #	Description	Lbs.	List
	SARG-72	812120	“SARG” Sweep Action Rock Grapple. 72” width with 1.25” round tines spaced 2.5” apart Patent Pending upper Sweep Action Grapples. Complete with “connect under pressure” flat-faced couplers.	1194	6,755.00
	SARG-84	812160	“SARG” Sweep Action Rock Grapple. 84” width with 1.25” round tines spaced 2.5” apart Patent Pending upper Sweep Action Grapples. Complete with “connect under pressure” flat-face couplers.	1344	7,343.00
Mini SARG (Sweep Action Rock Grapple) Designed for use on Mini Skid Steers / Compact Tool Carriers.					
Mini SARG	SARG-42	812230	Sweep Action Rock Grapple designed for Mini Skid Steers / Compact Tool Carriers. Unit is 42” wide with 1” round tines spaced 2.5” apart. Upper Sweep Action Grapple puts rocks/debris in the bucket, with “connect under pressure” flat face couplers	445	3,080.00
SARG-42 B/G		812270	Compact Sweep Action Rock Grapple for Bobcat MT-Mount mini skid steers	450	3,136.00
	Optional Bottom	812265	Optional Bolt-in 10-gauge bottom for SARG-42 provides bucket bottom to retain very small material	33	119.00